

## 8200 SERIES AUTOMATIC OPERATOR

# Introducing the automatic operator that changes everything.



### **Beauty, value and versatility are now automatic.**

When you need a smart solution to improve accessibility the new Falcon 8200 Series fits perfectly. Designed for applications like assisted living and ambulatory care, where ease of use is critical, the Falcon automatic operator provides dependable performance at an affordable price point. Everything you need is right in the box, making installation quick and simple. All necessary features are built right in, so configuring the closer is simple and you can easily make more openings more accessible than ever.



## 8200 SERIES AUTOMATIC OPERATOR

# FALCON

### Designed to fit perfectly.

The small footprint and elegant design of the Falcon 8200 Series make it a perfect solution for a range of applications.

- Assisted living
- Hospitality
- Retail
- Small office
- Restaurants
- Ambulatory care



Steel aluminum finished cover makes the 8200 Series aesthetically pleasing for any application.

One-piece mounting bracket eliminates the need for end caps, reducing parts and installation time.

Intelligent control box provides the most precise door operation and includes adjustable features for all commercial applications.







Non-handed motor gearbox uses mechanical controls to act as a size 3 door closer in manual operation.

Mounting bracket contains fastening notches to reduce parts and allow for faster and easier installation.

# 8200 SERIES AUTOMATIC OPERATOR

## 8200 Series

The new Falcon 8200 Series automatic operator ensures smooth, convenient door opening for areas requiring easy accessibility and ADA compliance. This versatile device can also be easily integrated into electrified openings with our wireless accessory offering. Choose the 8231 for pull side or the 8242 for push side installation.

-  **SmartLatch** – Senses and overcomes external pressure conditions with a graduated energy assist for secure latching.
-  **Push 'n' Go** – Selectable feature allows door to open automatically as soon as it feels pressure.
-  **Open Position Learning** – Automatically sets the opening position to eliminate wall and door damage.
-  **Obstacle Obstruction Detection** – Safety feature stops and reverses door direction when distress or an obstruction is sensed.
-  **Pre-Load Strike Assist** – Removes load on strike lip with a one second delay allowing the door to release and automatically open.
-  **LED Light Illumination** – Light illumination on control box signals accurate installation and helps with connection diagnostics.
-  **On Board Power Supply (12 VAC)** – Powers the accessories without the need to install an external power supply.

### Specifications

Header Length	26"
Mounting	Surface Mount
Handing	Non-handed
Cycle Tested	1 million gear box
Door weight	200 pounds

Consult technical services for use on doors over 200 lbs.

### Adjustable features:

Hold-open time delay	Backcheck speed
Backcheck/latch position	Opening/closing speed

## Actuators & Accessories



### 6" Round – Text with Logo

8310-852T	Push Plate, Wall Mount
8310-869F	Mounting Box, Flush
8310-869S	Mounting Box, Surface
8310-802	Weather Ring

8310-852T shown



### 1 1/2" x 4 3/4" Jamb – Text with Logo

8310-818T	Push Plate, Jamb Mount
8310-819F	Mounting Box, Flush
8310-819S	Mounting Box, Surface

8310-818T shown

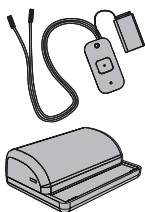

### Wireless Transmitters & Receiver

8310-844 Transmitter, Wall Mount (To be used with 6" round wall mounted actuator)
8310-844J Transmitter, Jamb Mount (To be used with 1 1/2" x 4 3/4" jamb actuator)
8310-861 Transmitter, Handheld (Single button wireless handheld transmitter)
8310-865 Receiver (Wireless receiver with sequencing function)

8310-844J and 8310-865 shown

# 8200 SERIES AUTOMATIC OPERATOR

# FALCON

## 26" Push System

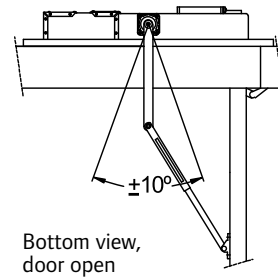
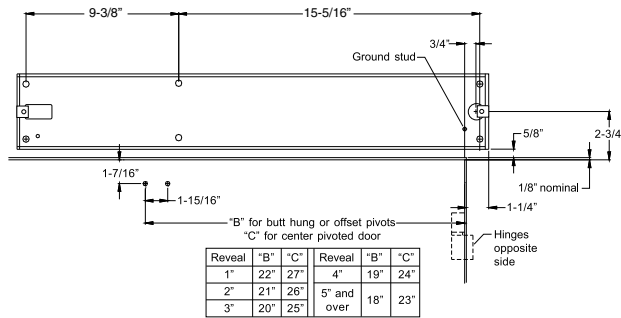

## 26" Pull System

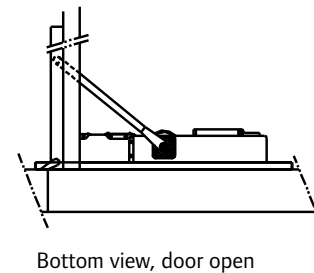
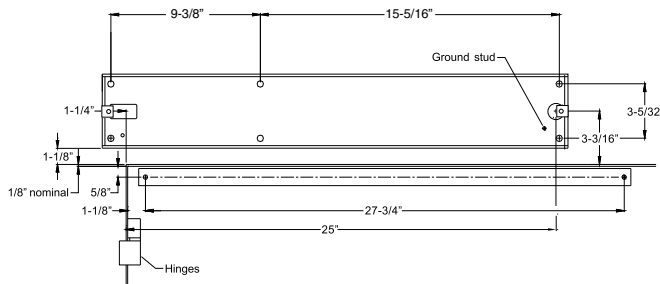

## 26" Drop System (Push System only)

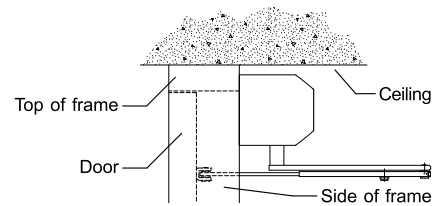
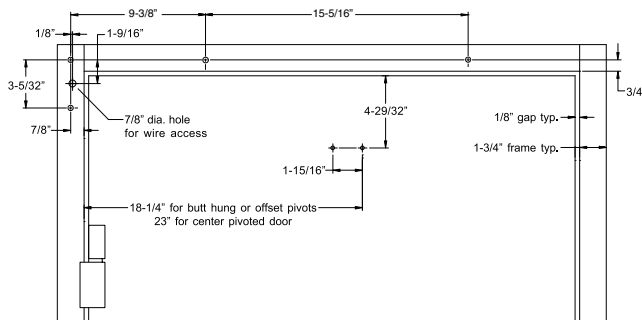

## HOW TO ORDER

### How to Order 8200 Series

**STD** Standard

**3**

**Full** 26"

**Aluminum**

**Push** 8242  
**Pull** 8231

**Order Separate** 8310-XXX

**Cylinder** **Size** **Cover** **Finish** **Arm** **Accessories**